

Industrielle Netzwerkkomponenten



Unmanaged Fast Ethernet Switch | Seite 25



Unmanaged Switch, M12 | Seite 32



IIoT-Gateway | Seite 33

Einführung	3
Managed BT PoE Gigabit Ethernet Switch	4
Unmanaged BT PoE Gigabit Ethernet Switch	5
Managed 10G Ethernet Switch	6
Unmanaged 10G Ethernet Switch	7
Managed Low Voltage PoE Gigabit Ethernet Switch	8
Managed Low Voltage PoE Gigabit Ethernet Switch	9
Managed Low Voltage PoE Fast Ethernet Switch	10
Managed PoE Gigabit Ethernet Switch	11
Managed PoE Gigabit Ethernet Switch	12
Managed PoE Fast Ethernet Switch	13
Managed Gigabit Ethernet Switch	14
Managed Gigabit Ethernet Switch	15
Managed Fast Ethernet Switch	16
Unmanaged Low Voltage PoE Gigabit Ethernet Switch	17
Unmanaged Low Voltage PoE Gigabit Ethernet Switch	18
Unmanaged PoE Gigabit Ethernet Switch	19
Unmanaged PoE Gigabit Ethernet Switch	20
Unmanaged PoE Fast Ethernet Switch	21
Unmanaged PoE Fast Ethernet Switch	22
Unmanaged Gigabit Ethernet Switch	23
Unmanaged Gigabit Ethernet Switch	24
Unmanaged Fast Ethernet Switch	25
Unmanaged Fast Ethernet Switch	26
Managed Ethernet Switch, 19" Rack Einbau	27
Unmanaged Ethernet Switch, 19" Rack Einbau	28
Medienkonverter	29
PoE Injektor	30
Managed Ethernet Switch, M12, Bahnanwendungen	31
Unmanaged Ethernet Switch, M12.	32
IIoT Gateway	33
Softwarefunktionen	35
Produktübersicht ERGATE	42

Einführung

Die folgende Grafik stellt eine Beispielfabrik dar, in der die Netzwerkkomponenten auf mehreren Ebenen zum Einsatz kommen: im Schaltschrank, auf der Ebene der Produktionslinie und auf der Leitebene. Auf jeder Ebene sind die Funktionen der Netzwerkkomponenten unterschiedlich, jedoch müssen die Produkte immer entsprechende Industriestandards erfüllen, vor allem für Störfestigkeit und raue Umgebungsbedingungen.

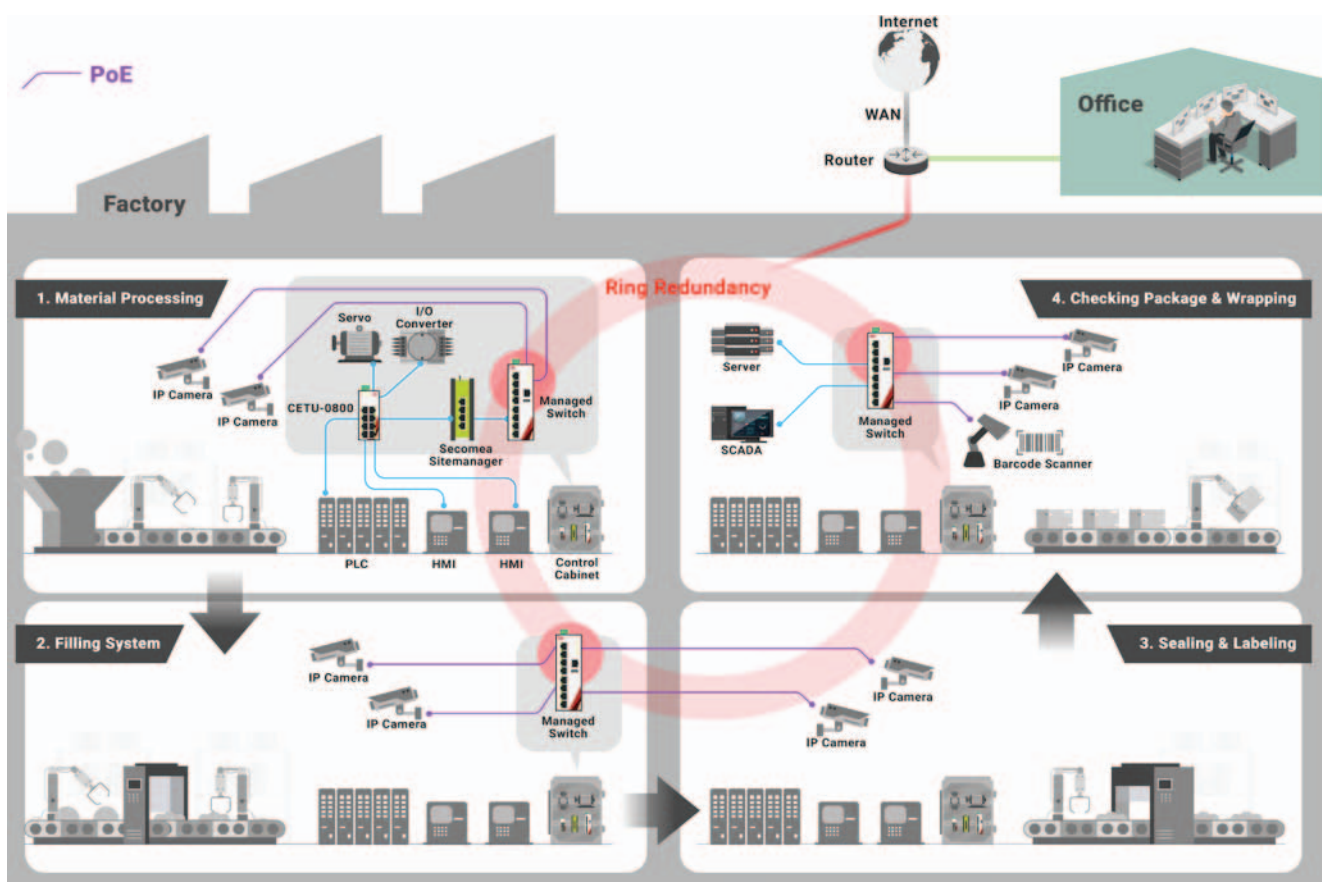

Unsere Ethernet Switche haben folgende unterschiedliche technische Eigenschaften:

5 Jahre Garantie

- Unmanaged und Managed Switch, Medienkonverter
- Anzahl der Ports: von 2 bis 28
- Art der Ports: Ethernet, LWL, SFP
- Geschwindigkeit: 100 MB/s, 1 GB/s, 10 GB/s
- PoE Option (kein PoE, PoE+ oder PoE++)
- Steckertyp: RJ45, M12, SFP, SC, ST, Combo
- Korrosionsfest
- Spezielle Anforderungen, z.B. für Bahn und andere Anwendungen



Managed BT PoE Gigabit Ethernet Switch



CBGM-0602-SFP



Artikel-Nr.	BGM-0702-SFP-24	BGM-0702-SFP	BGM-1204-SFP-24	BGM-1204-SFP	CBGM-0602-SFP
Allgemeine Spezifikationen					
Anzahl Ports	7	7	12	12	6
10/100/1000Base-Tx	4	4	8	8	4
100/1000Base-x SFP	2	2	4	4	2
IEEE 802.3bt PoE (P.S.E.)	4	4	4	4	4
Jumbo Frame Bedienung	✓	✓	✓	✓	✓
Spannungsversorgung					
Redundante Betriebsspannung	12–55 VDC	48–55 VDC	12–55 VDC	48–55 VDC	48–55 VDC
Überlastschutz	✓	✓	✓	✓	✓
Verpolungsschutz	✓	✓	✓	✓	✓
Relais 24VDC, 1A	✓	✓	✓	✓	✓
Mechanische Eigenschaften					
Gehäuse	Metall, IP30	Metall, IP30	Metall, IP30	Metall, IP30	Metall, IP30
Abmessungen in mm (B × H × T)	54 × 142 × 99	54 × 142 × 99	54 × 142 × 99	54 × 142 × 99	62 × 110 × 92
DIN-Schienenmontage oder Wandmontage	✓	✓	✓	✓	✓
Betriebstemperatur					
Standard (–10...+65 °C)	✓	✓	✓	✓	✓
Erweitert (–40...+75 °C)	✓	✓	✓	✓	✓
Konformität/Zulassungen					
EN 61000-6-4 / EN 61000-6-2	✓	✓	✓	✓	✓
FCC Part 15B / CISPR 22	✓	✓	✓	✓	✓
UL 61010	✓	✓	✓	✓	✓

Unmanaged BT PoE Gigabit Ethernet Switch

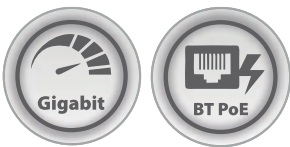

Artikel-Nr.	BGU-0500-24	BGU-0500	CBGU-0501-SFP-12	CBGU-0501-SFP	MBGU-0201-SFP-24	MBGU-0201-SFP
Allgemeine Spezifikationen						
Anzahl Ports	5	5	5	5	2	2
10/100/1000Base-Tx	5	5	4	4	1	1
100/1000Base-x SFP	-	-	1	1	1	1
IEEE 802.3bt PoE (P.S.E.)	4	4	4	4	1	1
Jumbo Frame Bedienung	✓	✓	✓	✓	✓	✓
Spannungsversorgung						
Redundante Betriebsspannung	12-55 VDC	48-55 VDC	9-55 VDC	48-55 VDC	12-55 VDC	48-55 VDC
Überlastschutz	✓	✓	✓	✓	✓	✓
Verpolungsschutz	✓	✓	✓	✓	✓	✓
Relais 24VDC, 1A	✓	✓	✓	✓	-	-
Mechanische Eigenschaften						
Gehäuse	Metall, IP30	Metall, IP30	Metall, IP30	Metall, IP30	Metall, IP30	Metall, IP30
Abmessungen in mm (B x H x T)	54 x 142 x 99	54 x 142 x 99	65 x 110 x 92	65 x 110 x 92	30 x 95 x 75	30 x 95 x 75
DIN-Schienenmontage oder Wandmontage	✓	✓	✓	✓	✓	✓
Betriebstemperatur						
Standard (-10...+65 °C)	✓	✓	✓	✓	✓	✓
Erweitert (-40...+75 °C)	✓	✓	✓	✓	✓	✓
Konformität/Zulassungen						
EN 61000-6-4 / EN 61000-6-2	✓	✓	✓	✓	✓	✓
FCC Part 15B / CISPR 22	✓	✓	✓	✓	✓	✓
UL 61010	✓	✓	✓	✓	✓	✓

Managed 10G Ethernet Switch



PGM-1002-10GSFP



Artikel-Nr.	PGM-1002-10GSFP-24	PGM-1002-10GSFP	EGM-1002-10GSFP
Allgemeine Spezifikationen			
Anzahl Ports	10	10	10
10/100/1000Base-Tx	8	8	8
10G SFP+	2	2	2
IEEE 802.3at PoE+ (P.S.E.)	8	8	-
Jumbo Frame Bedienung	✓	✓	✓
Spannungsversorgung			
Redundante Betriebsspannung	12-55 VDC	48-55 VDC	12-48 VDC
Überlastschutz	✓	✓	✓
Verpolungsschutz	✓	✓	✓
Relais 24VDC, 1A	✓	✓	✓
Mechanische Eigenschaften			
Gehäuse	Metall, IP30	Metall, IP30	Metall, IP30
Abmessungen in mm (B x H x T)	54 x 142 x 99	54 x 142 x 99	54 x 142 x 99
DIN-Schienenmontage oder Wandmontage	✓	✓	✓
Betriebstemperatur			
Standard	-40...+60 °C	-40...+60 °C	-40...+60 °C
Konformität/Zulassungen			
EN 61000-6-4 / EN 61000-6-2	✓	✓	✓
FCC Part 15B / CISPR 22	✓	✓	✓
UL 61010	✓	✓	✓

Unmanaged 10G Ethernet Switch



EGU-1002-10GSFP



Artikel-Nr.	PGU-1002-10GSFP-24	PGU-1002-10GSFP	EGU-1002-10GSFP	PGU-1204-SFP2-10GSFP2-24	PGU-1204-SFP2-10GSFP2	EGU-1204-SFP2-10GSFP2
Allgemeine Spezifikationen						
Anzahl Ports	10	10	10	12	12	12
10/100/1000Base-Tx	8	8	8	8	8	8
100/1000Base-x SFP	-	-	-	2	2	2
10G SFP+	2	2	2	2	2	2
IEEE 802.3at PoE+ (P.S.E.)	8	8	-	8	8	-
Jumbo Frame Bedienung	✓	✓	✓	✓	✓	✓
Spannungsversorgung						
Redundante Betriebsspannung	12-55 VDC	48-55 VDC	12-48 VDC	12-55 VDC	48-55 VDC	12-48 VDC
Überlastschutz	✓	✓	✓	✓	✓	✓
Verpolungsschutz	✓	✓	✓	✓	✓	✓
Relais 24VDC, 1A	✓	✓	✓	✓	✓	✓
Mechanische Eigenschaften						
Gehäuse	Metall, IP30	Metall, IP30	Metall, IP30	Metall, IP30	Metall, IP30	Metall, IP30
Abmessungen in mm (B x H x T)	54 x 142 x 99	54 x 142 x 99	54 x 142 x 99	54 x 142 x 99	54 x 142 x 99	54 x 142 x 99
DIN-Schienenmontage oder Wandmontage	✓	✓	✓	✓	✓	✓
Betriebstemperatur						
Standard	-40...+60 °C	-40...+60 °C	-40...+60 °C	-40...+60 °C	-40...+60 °C	-40...+60 °C
Konformität/Zulassungen						
EN 61000-6-4 / EN 61000-6-2	✓	✓	✓	✓	✓	✓
FCC Part 15B / CISPR 22	✓	✓	✓	✓	✓	✓
UL 61010	✓	✓	✓	✓	✓	✓

Managed Low Voltage PoE Gigabit Ethernet Switch



PGM-0601-SFP-24



Artikel-Nr.	PGM-0601-SFP-24	PGM-0602-SFP-24	PGM-0702-SFP-24	PGM-0800-24	PGM-0802-M-24	PGM-0802-SFP-24
Allgemeine Spezifikationen						
Anzahl Ports	6	6	7	8	8	8
10/100/1000Base-Tx	5	4	5	8	6	6
100/1000Base-x SFP	1	2	2	-	-	2
1000Base-x Fixed Fiber	-	-	-	-	2	-
IEEE 802.3at PoE+ (P.S.E.)	4	4	4	8	4	6
Jumbo Frame Bedienung	✓	✓	✓	✓	✓	✓
Spannungsversorgung						
Redundante Betriebsspannung	12-55 VDC	12-55 VDC	12-55 VDC	12-55 VDC	12-55 VDC	12-55 VDC
Überlastschutz	✓	✓	✓	✓	✓	✓
Verpolungsschutz	✓	✓	✓	✓	✓	✓
Relais 24VDC, 1A	✓	✓	✓	✓	✓	✓
Mechanische Eigenschaften						
Gehäuse	Metall, IP30	Metall, IP30	Metall, IP30	Metall, IP30	Metall, IP30	Metall, IP30
Abmessungen in mm (B x H x T)	54 x 142 x 99	54 x 142 x 99	54 x 142 x 99	54 x 142 x 99	54 x 142 x 99	54 x 142 x 99
DIN-Schienenmontage oder Wandmontage	✓	✓	✓	✓	✓	✓
Betriebstemperatur						
Standard (-10...+65 °C)	✓	✓	✓	✓	✓	✓
Erweitert (-40...+75 °C)	✓	✓	✓	✓	✓	✓
Konformität/Zulassungen						
EN 61000-6-4 / EN 61000-6-2	✓	✓	✓	✓	✓	✓
FCC Part 15B / CISPR 22	✓	✓	✓	✓	✓	✓
UL 61010	✓	-	✓	✓	✓	✓

Managed Low Voltage PoE Gigabit Ethernet Switch



PGM-1002-SFP-24



Artikel-Nr.	PGM-0804-SFP-24	PGM-1002-SFP-24	PGM-1202-SFP-24	PGM-1204-SFP-24
Allgemeine Spezifikationen				
Anzahl Ports	8	10	12	12
10/100/1000Base-Tx	4	8	10	8
100/1000Base-x SFP	4	2	2	4
IEEE 802.3at PoE+ (P.S.E.)	8	8	8	8
Jumbo Frame Bedienung	✓	✓	✓	✓
Spannungsversorgung				
Redundante Betriebsspannung	12–55 VDC	12–55 VDC	12–55 VDC	12–55 VDC
Überlastschutz	✓	✓	✓	✓
Verpolungsschutz	✓	✓	✓	✓
Relais 24VDC, 1A	✓	✓	✓	✓
Mechanische Eigenschaften				
Gehäuse	Metall, IP30	Metall, IP30	Metall, IP30	Metall, IP30
Abmessungen in mm (B x H x T)	54 x 142 x 99	54 x 142 x 99	54 x 142 x 99	54 x 142 x 99
DIN-Schienenmontage oder Wandmontage	✓	✓	✓	✓
Betriebstemperatur				
Standard (-10...+65 °C)	✓	✓	✓	✓
Erweitert (-40...+75 °C)	✓	✓	✓	✓
Konformität/Zulassungen				
EN 61000-6-4 / EN 61000-6-2	✓	✓	✓	✓
FCC Part 15B / CISPR 22	✓	✓	✓	✓
UL 61010	✓	✓	✓	✓
ISA 12.12.01 (C1D2)	-	✓	✓	✓
ATEX	-	✓	✓	✓
NEMA TS2	-	✓	✓	✓

Managed Low Voltage PoE Fast Ethernet Switch



PTM-0602-M-24



Artikel-Nr.	PTM-0501-M-24	PTM-0600-24	PTM-0602-M-24	PTM-1204-GT2-SFP2-24
Allgemeine Spezifikationen				
Anzahl Ports	5	6	6	12
10/100Base-Tx	4	6	4	8
10/100/1000Base-Tx	-	-	-	2
100Base-Fx Fixed Fiber	1	-	2	-
100/1000Base-x SFP	-	-	-	2
IEEE 802.3at PoE+ (P.S.E.)	4	4	4	8
Jumbo Frame Bedienung	-	-	-	✓
Spannungsversorgung				
Redundante Betriebsspannung	12-55 VDC	12-55 VDC	12-55 VDC	12-55 VDC
Überlastschutz	✓	✓	✓	✓
Verpolungsschutz	✓	✓	✓	✓
Relais 24VDC, 1A	✓	✓	✓	✓
Mechanische Eigenschaften				
Gehäuse	Metall, IP30	Metall, IP30	Metall, IP30	Metall, IP30
Abmessungen in mm (B × H × T)	54 × 142 × 99	54 × 142 × 99	54 × 142 × 99	54 × 142 × 99
DIN-Schienenmontage oder Wandmontage	✓	✓	✓	✓
Betriebstemperatur				
Standard (-10...+65 °C)	✓	✓	✓	✓
Erweitert (-40...+75 °C)	✓	✓	✓	✓
Konformität/Zulassungen				
EN 61000-6-4 / EN 61000-6-2	✓	✓	✓	✓
FCC Part 15B / CISPR 22	✓	✓	✓	✓
UL 61010	-	✓	✓	✓

Managed PoE Gigabit Ethernet Switch



PGM-0804-SFP



Artikel-Nr.	PGM-0601-SFP	PGM-0602-SFP	PGM-0702-SFP	PGM-0800	PGM-0802-SFP	PGM-0804-SFP	PGM-1002-SFP
Allgemeine Spezifikationen							
Anzahl Ports	6	6	7	8	8	8	10
10/100/1000Base-Tx	5	4	5	8	6	4	8
100/1000Base-x SFP	1	2	2	-	2	4	2
IEEE 802.3at PoE+ (P.S.E.)	4	4	4	8	6	4	8
Jumbo Frame Bedienung	✓	✓	✓	✓	✓	✓	✓
Spannungsversorgung							
Redundante Betriebsspannung	48-55 VDC	48-55 VDC	48-55 VDC	48-55 VDC	48-55 VDC	48-55 VDC	48-55 VDC
Überlastschutz	✓	✓	✓	✓	✓	✓	✓
Verpolungsschutz	✓	✓	✓	✓	✓	✓	✓
Relais 24VDC, 1A	✓	✓	✓	✓	✓	✓	✓
Mechanische Eigenschaften							
Gehäuse	Metall, IP30	Metall, IP30	Metall, IP30	Metall, IP30	Metall, IP30	Metall, IP30	Metall, IP30
Abmessungen in mm (B x H x T)	54 x 142 x 99	54 x 142 x 99	54 x 142 x 99	54 x 142 x 99	54 x 142 x 99	54 x 142 x 99	54 x 142 x 99
DIN-Schienenmontage oder Wandmontage	✓	✓	✓	✓	✓	✓	✓
Betriebstemperatur							
Standard (-10...+65 °C)	✓	✓	✓	✓	✓	✓	✓
Erweitert (-40...+75 °C)	✓	✓	✓	✓	✓	✓	✓
Konformität/Zulassungen							
EN 61000-6-4 / EN 61000-6-2	✓	✓	✓	✓	✓	✓	✓
FCC Part 15B / CISPR 22	✓	✓	✓	✓	✓	✓	✓
UL 61010	✓	-	✓	✓	✓	✓	✓
ISA 12.12.01 (C1D2)	-	-	-	-	-	-	✓
ATEX	-	-	-	-	-	-	✓
NEMA TS2	-	-	-	-	-	-	✓
Korrosionsschutz	-	-	-	-	-	-	✓ (CP)

Managed PoE Gigabit Ethernet Switch



PGM-2012-SFP



Artikel-Nr.	PGM-1202-SFP	PGM-1204-SFP	PGM-1600	PGM-1802-SFP	PGM-2004-SFP	PGM-2012-SFP
Allgemeine Spezifikationen						
Anzahl Ports	12	12	16	18	20	20
10/100/1000Base-Tx	10	8	16	16	16	8
100/1000Base-x SFP	2	4	-	2	4	12
IEEE 802.3at PoE+ (P.S.E.)	8	8	16	16	16	8
Jumbo Frame Bedienung	✓	✓	✓	✓	✓	✓
Spannungsversorgung						
Redundante Betriebsspannung	48-55 VDC	48-55 VDC	48-55 VDC	48-55 VDC	48-55 VDC	48-55 VDC
Überlastschutz	✓	✓	✓	✓	✓	✓
Verpolungsschutz	✓	✓	✓	✓	✓	✓
Relais 24VDC, 1A	✓	✓	✓	✓	✓	✓
Mechanische Eigenschaften						
Gehäuse	Metall, IP30	Metall, IP30	Metall, IP30	Metall, IP30	Metall, IP30	Metall, IP30
Abmessungen in mm (B x H x T)	54 x 142 x 99	54 x 142 x 99	67 x 142 x 99	67 x 142 x 99	67 x 142 x 99	72 x 142 x 99
DIN-Schienenmontage oder Wandmontage	✓	✓	✓	✓	✓	✓
Betriebstemperatur						
Standard (-10...+65 °C)	✓	✓	✓	✓	✓	✓
Erweitert (-40...+75 °C)	✓	✓	✓	✓	✓	✓
Konformität/Zulassungen						
EN 61000-6-4 / EN 61000-6-2	✓	✓	✓	✓	✓	✓
FCC Part 15B / CISPR 22	✓	✓	✓	✓	✓	✓
UL 61010	✓	✓	✓	✓	✓	-
ISA 12.12.01 (C1D2)	✓	✓	-	-	-	-
ATEX	✓	✓	-	-	-	-
NEMA TS2	✓	✓	-	-	-	-

Managed PoE Fast Ethernet Switch



PTM-0501-M



Artikel-Nr.	PTM-0501-M	PTM-0600	PTM-0602-M	PTM-1204-GT2-SFP2
Allgemeine Spezifikationen				
Anzahl Ports	5	6	6	12
10/100Base-Tx	4	6	4	8
10/100/1000Base-Tx	-	-	-	2
100Base-Fx Fixed Fiber	1	-	2	-
100/1000Base-x SFP	-	-	-	2
IEEE 802.3at PoE+ (P.S.E.)	4	4	4	8
Jumbo Frame Bedienung	✓	✓	✓	✓
Spannungsversorgung				
Redundante Betriebsspannung	48-55 VDC	48-55 VDC	48-55 VDC	48-55 VDC
Überlastschutz	✓	✓	✓	✓
Verpolungsschutz	✓	✓	✓	✓
Relais 24VDC, 1A	✓	✓	✓	✓
Mechanische Eigenschaften				
Gehäuse	Metall, IP30	Metall, IP30	Metall, IP30	Metall, IP30
Abmessungen in mm (B × H × T)	54 × 142 × 99	54 × 142 × 99	54 × 142 × 99	54 × 142 × 99
DIN-Schienenmontage oder Wandmontage	✓	✓	✓	✓
Betriebstemperatur				
Standard (-10...+65 °C)	✓	✓	✓	✓
Erweitert (-40...+75 °C)	✓	✓	✓	✓
Konformität/Zulassungen				
EN 61000-6-4 / EN 61000-6-2	✓	✓	✓	✓
FCC Part 15B / CISPR 22	✓	✓	✓	✓
UL 61010	-	✓	✓	✓

Managed Gigabit Ethernet Switch



EGM-0802-SFP



Artikel-Nr.	EGM-0501-SFP	EGM-0601-SFP	CEGM-0602-SFP	EGM-0602-SFP	EGM-0702-SFP	EGM-0800	EGM-0802-SFP
Allgemeine Spezifikationen							
Anzahl Ports	5	6	6	6	7	8	8
10/100/1000Base-Tx	4	5	4	4	5	8	6
100/1000Base-x SFP	1	1	2	2	2	-	2
Jumbo Frame Bedienung	✓	✓	✓	✓	✓	✓	✓
Spannungsversorgung							
Redundante Betriebsspannung	12-48 VDC	12-48 VDC	12-48 VDC	12-48 VDC	12-48 VDC	12-48 VDC	12-48 VDC
Überlastschutz	✓	✓	✓	✓	✓	✓	✓
Verpolungsschutz	✓	✓	✓	✓	✓	✓	✓
Relais 24VDC, 1A	✓	✓	✓	✓	✓	✓	✓
Mechanische Eigenschaften							
Gehäuse	Metall, IP30	Metall, IP30	Metall, IP30	Metall, IP30	Metall, IP30	Metall, IP30	Metall, IP30
Abmessungen in mm (B x H x T)	54 x 142 x 99	54 x 142 x 99	65 x 110 x 90	54 x 142 x 99	54 x 142 x 99	54 x 142 x 99	54 x 142 x 99
DIN-Schienenmontage oder Wandmontage	✓	✓	✓	✓	✓	✓	✓
Betriebstemperatur							
Standard (-10...+65 °C)	✓	✓	✓	✓	✓	✓	✓
Erweitert (-40...+75 °C)	✓	✓	✓	✓	✓	✓	✓
Konformität/Zulassungen							
EN 61000-6-4 / EN 61000-6-2	✓	✓	✓	✓	✓	✓	✓
FCC Part 15B / CISPR 22	✓	✓	✓	✓	✓	✓	✓
UL 61010	-	✓	-	-	✓	✓	✓

Managed Gigabit Ethernet Switch



EGM-0804-SFP



Artikel-Nr.	EGM-0804-SFP	EGM-1002-SFP	EGM-1202-SFP	EGM-1204-SFP	EGM-1600	EGM-1802-SFP	EGM-2004-SFP	EGM-2012-SFP
Allgemeine Spezifikationen								
Anzahl Ports	8	10	12	12	16	18	20	20
10/100/1000Base-Tx	4	8	10	8	16	16	16	8
100/1000Base-x SFP	4	2	2	4	-	2	4	12
Jumbo Frame Bedienung	✓	✓	✓	✓	✓	✓	✓	✓
Spannungsversorgung								
Redundante Betriebsspannung	12-48 VDC	12-48 VDC	12-48 VDC	12-48 VDC	12-48 VDC	12-48 VDC	12-48 VDC	12-48 VDC
Überlastschutz	✓	✓	✓	✓	✓	✓	✓	✓
Verpolungsschutz	✓	✓	✓	✓	✓	✓	✓	✓
Relais 24VDC, 1A	✓	✓	✓	✓	✓	✓	✓	✓
Mechanische Eigenschaften								
Gehäuse	Metall, IP30	Metall, IP30	Metall, IP30	Metall, IP30	Metall, IP30	Metall, IP30	Metall, IP30	Metall, IP30
Abmessungen in mm (B x H x T)	54 x 142 x 99	54 x 142 x 99	54 x 142 x 99	54 x 142 x 99	67x 142 x 99	67 x 142 x 99	67 x 142 x 99	72 x 142 x 99
DIN-Schienenmontage oder Wandmontage	✓	✓	✓	✓	✓	✓	✓	✓
Betriebstemperatur								
Standard (-10...+65 °C)	✓	✓	✓	✓	✓	✓	✓	✓
Erweitert (-40...+75 °C)	✓	✓	✓	✓	✓	✓	✓	✓
Konformität/Zulassungen								
EN 61000-6-4 / EN 61000-6-2	✓	✓	✓	✓	✓	✓	✓	✓
FCC Part 15B / CISPR 22	✓	✓	✓	✓	✓	✓	✓	✓
UL 61010	✓	✓	✓	✓	✓	✓	✓	-
ISA 12.12.01 (C1D2)	-	✓	✓	✓	-	-	-	-
ATEX	-	✓	✓	✓	-	-	-	-
NEMA TS2	-	✓	✓	✓	-	-	-	-
Korrosionsschutz	-	✓ (CP)	-	-	-	-	-	-

Managed Fast Ethernet Switch



ETM-0800



Artikel-Nr.	ETM-0500	ETM-0600	ETM-0602-M	ETM-0802-M	ETM-0800	ETM-1204-GT2-SFP2
Allgemeine Spezifikationen						
Anzahl Ports	5	6	6	8	8	12
10/100Base-Tx	5	6	4	6	8	8
10/100/1000Base-Tx	-	-	-	-	-	2
100Base-Fx Fixed Fiber	-	-	2	2	-	-
100/1000Base-x SFP	-	-	-	-	-	2
Jumbo Frame Bedienung	✓	✓	✓	✓	✓	✓
Spannungsversorgung						
Redundante Betriebsspannung	12-48 VDC	12-48 VDC	12-48 VDC	12-48 VDC	12-48 VDC	12-48 VDC
Überlastschutz	✓	✓	✓	✓	✓	✓
Verpolungsschutz	✓	✓	✓	✓	✓	✓
Relais 24VDC, 1A	✓	✓	✓	✓	✓	✓
Mechanische Eigenschaften						
Gehäuse	Metall, IP30	Metall, IP30	Metall, IP30	Metall, IP30	Metall, IP30	Metall, IP30
Abmessungen in mm (B x H x T)	54 x 142 x 99	54 x 142 x 99	54 x 142 x 99	54 x 142 x 99	54 x 142 x 99	54 x 142 x 99
DIN-SchieneMontage oder Wandmontage	✓	✓	✓	✓	✓	✓
Betriebstemperatur						
Standard (-10...+65 °C)	✓	✓	✓	✓	✓	✓
Erweitert (-40...+75 °C)	✓	✓	✓	✓	✓	✓
Konformität/Zulassungen						
EN 61000-6-4 / EN 61000-6-2	✓	✓	✓	✓	✓	✓
FCC Part 15B / CISPR 22	✓	✓	✓	✓	✓	✓
UL 61010	✓	✓	✓	✓	✓	✓

Unmanaged Low Voltage PoE Gigabit Ethernet Switch



PGU-0702-SFP-24

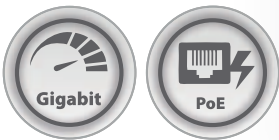

Artikel-Nr.	PGU-0500-24	PGU-0702-SFP-24	PGU-0800-12	PGU-1002-SFP-24	PGU-1202-SFP-24
Allgemeine Spezifikationen					
Anzahl Ports	5	7	8	10	12
10/100/1000Base-Tx	5	5	8	8	10
100/1000Base-x SFP	-	2	-	2	2
IEEE 802.3at PoE+ (P.S.E.)	4	4	8	8	8
Jumbo Frame Bedienung	✓	✓	✓	✓	✓
Spannungsversorgung					
Redundante Betriebsspannung	12-36 VDC	12-36 VDC	12-36 VDC	12-36 VDC	12-36 VDC
Überlastschutz	✓	✓	✓	✓	✓
Verpolungsschutz	✓	✓	✓	✓	✓
Relais 24VDC, 1A	✓	✓	✓	✓	✓
Mechanische Eigenschaften					
Gehäuse	Metall, IP30	Metall, IP30	Metall, IP30	Metall, IP30	Metall, IP30
Abmessungen in mm (B x H x T)	46 x 142 x 99	46 x 142 x 99	41 x 144.5 x 95	46 x 142 x 99	46 x 142 x 99
DIN-Schienenmontage oder Wandmontage	✓	✓	✓	✓	✓
Betriebstemperatur					
Standard (-10...+65 °C)	✓	✓	✓	✓	✓
Erweitert (-40...+75 °C)	✓	✓	✓	✓	✓
Konformität/Zulassungen					
EN 61000-6-4 / EN 61000-6-2	✓	✓	✓	✓	✓
FCC Part 15B / CISPR 22	✓	✓	✓	✓	✓
UL 508	-	-	✓	-	-
UL 61010	✓	✓	-	✓	✓
ISA 12.12.01 (C1D2)	✓	✓	✓	✓	✓
Korrosionsschutz	-	-	✓ (CP)	-	-

Unmanaged Low Voltage PoE Gigabit Ethernet Switch



PTU-0800-24



Artikel-Nr.	PTU-0500-24	PTU-0501-M-24	PTU-0702-SFP-24	PTU-0800-24	PTU-0800-M-24	PTU-0802-2C-24	PTU-1002-2C-24
Allgemeine Spezifikationen							
Anzahl Ports	5	5	7	8	8	8	10
10/100Base-Tx	5	4	5	8	6	6	8
10/100/1000Base-Tx	-	-	-	-	-	2 w/combo	2 w/combo
100Base-FX Fixed Fiber	-	1	-	-	2	-	-
100/1000Base-X SFP	-	-	2	-	-	2 w/combo	2 w/combo
IEEE 802.3at PoE+ (P.S.E.)	4	4	4	8	6	6	8
Spannungsversorgung							
Redundante Betriebsspannung	12-36 VDC	12-36 VDC	12-36 VDC	12-36 VDC	12-36 VDC	12-36 VDC	12-36 VDC
Überlastschutz	✓	✓	✓	✓	✓	✓	✓
Verpolungsschutz	✓	✓	✓	✓	✓	✓	✓
Relais 24VDC, 1A	✓	✓	✓	✓	✓	✓	✓
Mechanische Eigenschaften							
Gehäuse	Metall, IP30	Metall, IP30	Metall, IP30	Metall, IP30	Metall, IP30	Metall, IP30	Metall, IP30
Abmessungen in mm (B x H x T)	46 x 142 x 99	46 x 142 x 99	46 x 142 x 99	46 x 142 x 99	46 x 142 x 99	46 x 142 x 99	46 x 142 x 99
DIN-Schienenmontage oder Wandmontage	✓	✓	✓	✓	✓	✓	✓
Betriebstemperatur							
Standard (-10...+65 °C)	✓	✓	✓	✓	✓	✓	✓
Erweitert (-40...+75 °C)	✓	✓	✓	✓	✓	✓	✓
Konformität/Zulassungen							
EN 61000-6-4 / EN 61000-6-2	✓	✓	✓	✓	✓	✓	✓
FCC Part 15B / CISPR 22	✓	✓	✓	✓	✓	✓	✓
UL 508	✓	✓	-	✓	✓	-	-
UL 61010	-	-	✓	-	-	✓	✓
ISA 12.12.01 (C1D2)	✓	✓	✓	✓	✓	✓	✓

Unmanaged PoE Gigabit Ethernet Switch



CPGU-0500

Artikel-Nr.	CPGU-0500	PGU-0500	PGU-0601-SFP	PGU-0702-SFP	PGU-0800	PGU-1002-SFP
Allgemeine Spezifikationen						
Anzahl Ports	5	5	6	7	8	10
10/100/1000Base-Tx	5	5	5	5	8	8
100/1000Base-x SFP	–	–	1	2	–	2
IEEE 802.3at PoE+ (P.S.E.)	4	4	4	4	8	8
Jumbo Frame Bedienung	✓	✓	✓	✓	✓	✓
Spannungsversorgung						
Redundante Betriebsspannung	48–55 VDC	48–55 VDC	48–55 VDC	48–55 VDC	48–55 VDC	48–55 VDC
Überlastschutz	✓	✓	✓	✓	✓	✓
Verpolungsschutz	✓	✓	✓	✓	✓	✓
Relais 24VDC, 1A	–	✓	✓	✓	✓	✓
Mechanische Eigenschaften						
Gehäuse	Metall, IP30	Metall, IP30	Metall, IP30	Metall, IP30	Metall, IP30	Metall, IP30
Abmessungen in mm (B x H x T)	30 x 95 x 75	30 x 142 x 99	30 x 142 x 99	30 x 142 x 99	30 x 142 x 99	46 x 142 x 99
DIN-Schienenmontage oder Wandmontage	✓	✓	✓	✓	✓	✓
Betriebstemperatur						
Standard (–10...+65 °C)	✓	✓	✓	✓	✓	✓
Erweitert (–40...+75 °C)	✓	✓	✓	✓	✓	✓
Konformität/Zulassungen						
EN 61000-6-4 / EN 61000-6-2	✓	✓	✓	✓	✓	✓
FCC Part 15B / CISPR 22	✓	✓	✓	✓	✓	✓
UL 508	–	–	–	–	✓	–
UL 61010	✓	✓	✓	✓	–	✓
ISA 12.12.01 (C1D2)	–	✓	✓	✓	✓	✓

Unmanaged PoE Gigabit Ethernet Switch

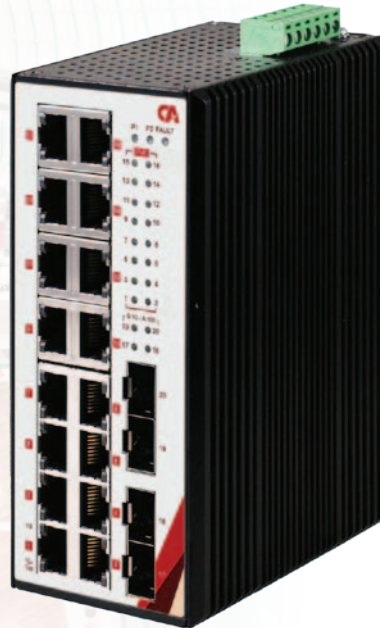

PGU-2004-SFP

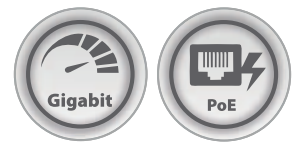

Artikel-Nr.	PGU-1202-SFP	PGU-1204-SFP	PGU-1604-SFP	PGU-1600	PGU-1802-SFP	PGU-2004-SFP
Allgemeine Spezifikationen						
Anzahl Ports	12	12	16	16	18	20
10/100/1000Base-Tx	10	8	12	16	16	16
100/1000Base-x SFP	2	4	4	–	2	4
IEEE 802.3at PoE+ (P.S.E.)	8	8	12	16	16	16
Jumbo Frame Bedienung	✓	✓	✓	✓	✓	✓
Spannungsversorgung						
Redundante Betriebsspannung	48–55 VDC	48–55 VDC	48–55 VDC	48–55 VDC	48–55 VDC	48–55 VDC
Überlastschutz	✓	✓	✓	✓	✓	✓
Verpolungsschutz	✓	✓	✓	✓	✓	✓
Relais 24VDC, 1A	✓	✓	✓	✓	✓	✓
Mechanische Eigenschaften						
Gehäuse	Metall, IP30	Metall, IP30	Metall, IP30	Aluminum, IP30	Aluminum, IP30	Aluminum, IP30
Abmessungen in mm (B × H × T)	46 × 142 × 99	46 × 142 × 99	59 × 142 × 99	67 × 142 × 99	67 × 142 × 99	67 × 142 × 99
DIN-Schienenmontage oder Wandmontage	✓	✓	✓	✓	✓	✓
Betriebstemperatur						
Standard (–10...+65 °C)	✓	✓	✓	✓	✓	✓
Erweitert (–40...+75 °C)	✓	✓	✓	✓	✓	✓
Konformität/Zulassungen						
EN 61000-6-4 / EN 61000-6-2	✓	✓	✓	✓	✓	✓
FCC Part 15 B / CISPR 22	✓	✓	✓	✓	✓	✓
UL 61010	✓	✓	–	–	–	–
ISA 12.12.01 (C1D2)	✓	–	–	–	–	–
EN 50121-4	–	–	✓	–	–	–

Unmanaged PoE Fast Ethernet Switch



PTU-0500



Artikel-Nr.	PTU-0500	PTU-0501-M	PTU-0602-M	PTU-0702-SFP
Allgemeine Spezifikationen				
Anzahl Ports	5	5	6	7
10/100Base-Tx	5	4	4	5
100Base-Fx Fixed Fiber	–	1	2	–
100/1000Base-x SFP	–	–	–	2
IEEE 802.3at PoE+ (P.S.E.)	4	4	4	4
Spannungsversorgung				
Redundante Betriebsspannung	48–55 VDC	48–55 VDC	48–55 VDC	48–55 VDC
Überlastschutz	✓	✓	✓	✓
Verpolungsschutz	✓	✓	✓	✓
Relais 24VDC, 1A	✓	✓	✓	✓
Mechanische Eigenschaften				
Gehäuse	Metall, IP30	Metall, IP30	Metall, IP30	Metall, IP30
Abmessungen in mm (B × H × T)	30 × 142 × 99	30 × 142 × 99	30 × 142 × 99	30 × 142 × 99
DIN-Schienenmontage oder Wandmontage	✓	✓	✓	✓
Betriebstemperatur				
Standard (–10...+65 °C)	✓	✓	✓	✓
Erweitert (–40...+75 °C)	✓	✓	✓	✓
Konformität/Zulassungen				
EN 61000-6-4 / EN 61000-6-2	✓	✓	✓	✓
FCC Part 15B / CISPR 22	✓	✓	✓	✓
UL 508	✓	✓	✓	–
UL 61010	–	–	–	✓
ISA 12.12.01 (C1D2)	✓	✓	✓	✓

Unmanaged PoE Fast Ethernet Switch



PTU-1002-2C



Artikel-Nr.	PTU-0800	PTU-0802-M	PTU-0802-2C	PTU-1002-2C
Allgemeine Spezifikationen				
Anzahl Ports	8	8	8	10
10/100Base-Tx	8	6	6	8
10/100/1000Base-Tx	-	-	2 w/combo	2 w/combo
100Base-Fx Fixed Fiber	-	2	-	-
100/1000Base-x SFP	-	-	2 w/combo	2 w/combo
IEEE 802.3at PoE+ (P.S.E.)	8	6	6	8
Spannungsversorgung				
Redundante Betriebsspannung	48-55 VDC	48-55 VDC	48-55 VDC	48-55 VDC
Überlastschutz	✓	✓	✓	✓
Verpolungsschutz	✓	✓	✓	✓
Relais 24VDC, 1A	✓	✓	✓	✓
Mechanische Eigenschaften				
Gehäuse	Metall, IP30	Metall, IP30	Metall, IP30	Metall, IP30
Abmessungen in mm (B × H × T)	30 × 142 × 99	46 × 142 × 99	46 × 142 × 99	46 × 142 × 99
DIN-Schienenmontage oder Wandmontage	✓	✓	✓	✓
Betriebstemperatur				
Standard (-10...+65 °C)	✓	✓	✓	✓
Erweitert (-40...+75 °C)	✓	✓	✓	✓
Konformität/Zulassungen				
EN 61000-6-4 / EN 61000-6-2	✓	✓	✓	✓
FCC Part 15B / CISPR 22	✓	✓	✓	✓
UL 508	✓	✓	-	-
UL 61010	-	-	✓	✓
ISA 12.12.01 (C1D2)	✓	✓	✓	✓

Unmanaged Gigabit Ethernet Switch



EGU-0501-SFP



Artikel-Nr.	CEGU-0500	EGU-0500	CEGU-0501-SFP	EGU-0501-SFP	EGU-0601-SFP	EGU-0702-SFP	CEGU-0800	EGU-0800
Allgemeine Spezifikationen								
Anzahl Ports	5	5	5	5	6	7	8	8
10/100/1000Base-Tx	5	5	4	4	5	5	8	8
100/1000Base-x SFP	-	-	1	1	1	2	-	-
Jumbo Frame Bedienung	✓	✓	✓	✓	✓	✓	✓	✓
Spannungsversorgung								
Redundante Betriebsspannung	12-48 VDC	12-48 VDC	12-48 VDC	12-48 VDC	12-48 VDC	12-48 VDC	12-48 VDC	12-48 VDC
Überlastschutz	✓	✓	✓	✓	✓	✓	✓	✓
Verpolungsschutz	✓	✓	✓	✓	✓	✓	✓	✓
Relais 24VDC, 1A	-	✓	✓	✓	✓	✓	✓	✓
Mechanische Eigenschaften								
Gehäuse	Metall, IP30	Metall, IP30	Metall, IP30	Metall, IP30	Metall, IP30	Metall, IP30	Metall, IP30	Metall, IP30
Abmessungen in mm (B x H x T)	26 x 95 x 75	30 x 140 x 95	65 x 110 x 90	30 x 140 x 95	30 x 140 x 95	30 x 142 x 99	40 x 95 x 70	30 x 140 x 95
DIN-Schienenmontage oder Wandmontage	✓	✓	✓	✓	✓	✓	✓	✓
Betriebstemperatur								
Standard (-10...+65 °C)	✓	✓	✓	✓	✓	✓	✓	✓
Erweitert (-40...+75 °C)	✓	✓	✓	✓	✓	✓	✓	✓
Konformität/Zulassungen								
EN 61000-6-4 / EN 61000-6-2	✓	✓	✓	✓	✓	✓	✓	✓
FCC Part 15B / CISPR 22	✓	✓	✓	✓	✓	✓	✓	✓
UL 61010	✓	✓	✓	✓	✓	✓	-	✓
ISA 12.12.01 (C1D2)	-	✓	-	✓	✓	✓	-	-

Unmanaged Gigabit Ethernet Switch



EGU-1802-SFP



Artikel-Nr.	EGU-1002-SFP	EGU-1202-SFP	EGU-1204-SFP	EGU-1604-SFP	EGU-1600	EGU-1802-SFP	EGU-2004-SFP
Allgemeine Spezifikationen							
Anzahl Ports	10	12	12	16	16	18	20
10/100/1000Base-Tx	8	10	8	12	16	16	16
100/1000Base-x SFP	2	2	4	4	-	2	4
Jumbo Frame Bedienung	✓	✓	✓	✓	✓	✓	✓
Spannungsversorgung							
Redundante Betriebsspannung	12-48 VDC	12-48 VDC	12-48 VDC	12-48 VDC	12-48 VDC	12-48 VDC	12-48 VDC
Überlastschutz	✓	✓	✓	✓	✓	✓	✓
Verpolungsschutz	✓	✓	✓	✓	✓	✓	✓
Relais 24VDC, 1A	✓	✓	✓	✓	✓	✓	✓
Mechanische Eigenschaften							
Gehäuse	Metall, IP30	Metall, IP30	Metall, IP30	Metall, IP30	Aluminium, IP30	Aluminium, IP30	Aluminium, IP30
Abmessungen in mm (B x H x T)	46 x 142 x 99	46 x 142 x 99	46 x 142 x 99	59 x 142 x 99	67 x 142 x 99	67 x 142 x 99	67 x 142 x 99
DIN-Schienenmontage oder Wandmontage	✓	✓	✓	✓	✓	✓	✓
Betriebstemperatur							
Standard (-10...+65 °C)	✓	✓	✓	✓	✓	✓	✓
Erweitert (-40...+75 °C)	✓	✓	✓	✓	✓	✓	✓
Konformität/Zulassungen							
EN 61000-6-4 / EN 61000-6-2	✓	✓	✓	✓	✓	✓	✓
FCC Part 15 B / CISPR 22	✓	✓	✓	✓	✓	✓	✓
UL 61010	✓	✓	✓	-	-	-	-
ISA 12.12.01 (C1D2)	✓	✓	-	-	-	-	-
EN 50121-4	-	-	-	✓	-	-	-

Unmanaged Fast Ethernet Switch



CETU-0500

Artikel-Nr.	CETU-0500	ETU-0500	ETU-0501-M	ETU-0602-M	ETU-0702-SFP
Allgemeine Spezifikationen					
Anzahl Ports	5	5	5	6	7
10/100Base-Tx	5	5	4	4	5
10/100/1000Base-Tx	-	-	-	-	-
100Base-Fx Fixed Fiber	-	-	1	2	-
100/1000Base-x SFP	-	-	-	-	2
Spannungsversorgung					
Redundante Betriebsspannung	12-48 VDC	12-48 VDC	12-48 VDC	12-48 VDC	12-48 VDC
Überlastschutz	✓	✓	✓	✓	✓
Verpolungsschutz	✓	✓	✓	✓	✓
Relais 24VDC, 1A	-	✓	✓	✓	✓
Mechanische Eigenschaften					
Gehäuse	Metall, IP30	Metall, IP30	Metall, IP30	Metall, IP30	Metall, IP30
Abmessungen in mm (B x H x T)	26 x 95 x 75	30 x 142 x 99	30 x 142 x 99	30 x 142 x 99	30 x 142 x 99
DIN-Schienenmontage oder Wandmontage	✓	✓	✓	✓	✓
Betriebstemperatur					
Standard (-10...+65 °C)	✓	✓	✓	✓	✓
Erweitert (-40...+75 °C)	✓	✓	✓	✓	✓
Konformität/Zulassungen					
EN 61000-6-4 / EN 61000-6-2	✓	✓	✓	✓	✓
FCC Part 15B / CISPR 22	✓	✓	✓	✓	✓
UL 508	-	-	✓	✓	-
UL 61010	✓	✓	-	-	✓
ISA 12.12.01 (C1D2)	-	✓	✓	✓	✓

Unmanaged Fast Ethernet Switch



CETU-0800

Artikel-Nr.	CETU-0800	ETU-0800	ETU-1002-2C	ETU-1600
Allgemeine Spezifikationen				
Anzahl Ports	8	8	10	16
10/100Base-Tx	8	8	8	16
10/100/1000Base-Tx	-	-	2 w/ combo	-
100/1000Base-x SFP	-	-	2 w/ combo	-
Spannungsversorgung				
Redundante Betriebsspannung	12-48 VDC	12-48 VDC	12-48 VDC	12-48 VDC
Überlastschutz	✓	✓	✓	✓
Verpolungsschutz	✓	✓	✓	✓
Relais 24VDC, 1A	✓	✓	✓	✓
Mechanische Eigenschaften				
Gehäuse	Metall, IP30	Metall, IP30	Metall, IP30	Metall, IP30
Abmessungen in mm (B x H x T)	40 x 95 x 70	30 x 142 x 99	30 x 142 x 99	30 x 142 x 99
DIN-Schienenmontage oder Wandmontage	✓	✓	✓	✓
Betriebstemperatur				
Standard (-10...+65 °C)	✓	✓	✓	✓
Erweitert (-40...+75 °C)	✓	✓	✓	✓
Konformität/Zulassungen				
EN 61000-6-4 / EN 61000-6-2	✓	✓	✓	✓
FCC Part 15B / CISPR 22	✓	✓	✓	✓
UL 61010	✓	✓	✓	✓
ISA 12.12.01 (C1D2)	-	-	✓	-

Managed Ethernet Switch, 19" Rack Einbau



RPGM-2602-2C



Artikel-Nr.	RPGM-2602-2C	REGM-2602-2C	RPGM-2804-10GSFP-24	REGM-2804-10GSFP-24
Allgemeine Spezifikationen				
Anzahl Ports	26	26	28	28
10/100/1000Base-Tx	24 + 2 w/ combo	24 + 2 w/ combo	24	24
100/1000Base-x SFP	2 w/ combo	2 w/ combo	-	-
1G/10G SFP+	-	-	4	4
IEEE 802.3at PoE+ (P.S.E.)	24	-	24	-
Jumbo Frame Bedienung	✓	✓	✓	✓
Spannungsversorgung				
Redundante Betriebsspannung	48-55 VDC	90-264 VAC, 47-63 Hz	12-55 VDC	12-48 VDC
Überlastschutz	✓	✓	✓	✓
Verpolungsschutz	✓	-	-	-
Relais 24VDC, 1A	✓	-	-	-
Mechanische Eigenschaften				
Gehäuse	Metall, IP30	Metall, IP30	Metall, IP30	Metall, IP30
Abmessungen in mm (B x H x T)	440 x 44 x 200	440 x 44 x 200	-	-
19" Rack Einbau	✓	✓	✓	✓
Betriebstemperatur				
Standard (-10...+65 °C)	✓	✓	✓	✓
Erweitert (-40...+75 °C)	✓	✓	✓	✓
Konformität/Zulassungen				
EN 61000-6-4 / EN 61000-6-2	✓	✓	✓	✓
FCC Part 15B / CISPR 22	✓	✓	✓	✓
UL 61010	✓	✓	✓	✓
ISA 12.12.01 (C1D2)	-	-	✓	-

Unmanaged Ethernet Switch, 19" Rack Einbau



RPGU-2602-2C



Artikel-Nr.	RPGU-2602-2C	REGU-2602-2C
Allgemeine Spezifikationen		
Anzahl Ports	26	26
10/100/1000Base-Tx	24 + 2 w/ combo	24 + 2 w/ combo
100/1000Base-x SFP	2 w/ combo	2 w/ combo
IEEE 802.3at PoE+ (P.S.E.)	24	-
Jumbo Frame Bedienung	✓	✓
Spannungsversorgung		
Redundante Betriebsspannung	48-55 VDC	90-264 VAC/47-63Hz
Überlastschutz	✓	✓
Verpolungsschutz	✓	✓
Relais 24VDC, 1A	✓	-
Mechanische Eigenschaften		
Gehäuse	Metall, IP30	Metall, IP30
Abmessungen in mm (B x H x T)	440 x 44 x 200	440 x 44 x 200
19" Rack Einbau	✓	✓
Betriebstemperatur		
Standard (-10...+65 °C)	✓	✓
Erweitert (-40...+75 °C)	✓	✓
Konformität/Zulassungen		
EN 61000-6-4 / EN 61000-6-2	✓	✓
FCC Part 15B / CISPR 22	✓	✓

Medienkonverter



MPGU-0201-SFP



Artikel-Nr.	MEGU-0201-SFP	MPGU-0201-SFP	MEGU-0201-M	METU-0201-M	METU-0201-M
Allgemeine Spezifikationen					
Anzahl Ports	2	2	2	2	2
10/100Base-Tx	-	-	-	1	1
10/100/1000Base-Tx	1	1	1	-	-
100/1000Base-x SFP	1	1	-	-	-
100Base-Fx Fixed Fiber	-	-	-	1	1
1000Base-x Fixed Fiber	-	-	1	-	-
IEEE 802.3at PoE+ (P.S.E.)	-	1	-	-	1
Jumbo Frame Bedienung	✓	✓	✓	-	-
Spannungsversorgung					
Redundante Betriebsspannung	12-48 VDC	48-55 VDC	12-48 VDC	12-48 VDC	48-55 VDC
Überlastschutz	✓	✓	✓	✓	✓
Verpolungsschutz	✓	✓	✓	✓	✓
Relais 24VDC, 1A	-	-	-	✓	✓
Mechanische Eigenschaften					
Gehäuse	Metall, IP30	Metall, IP30	Metall, IP30	Metall, IP30	Metall, IP30
Abmessungen in mm (B x H x T)	26 x 95 x 75	26 x 95 x 75	26 x 95 x 75	26 x 95 x 75	26 x 95 x 75
DIN-Schienenmontage oder Wandmontage	✓	✓	✓	✓	✓
Betriebstemperatur					
Standard (-10...+70 °C)	✓	✓	✓	✓	✓
Erweitert(-40...+80 °C)	✓	✓	✓	✓	✓
Konformität/Zulassungen					
EN 61000-6-4 / EN 61000-6-2	✓	✓	✓	✓	✓
FCC Part 15B / CISPR 22	✓	✓	✓	✓	✓
UL 61010	✓	✓	✓	-	-

PoE Injektor



GINJ-0201-BT-24

Artikel-Nr.	GINJ-0201-AT-24	GINJ-0201-BT-24
Allgemeine Spezifikationen		
Anzahl Ports	2	2
10/100/1000Base-Tx	2	2
IEEE 802.3at PoE+ (P.S.E.)	1	1
Spannungsversorgung PoE	30 W	90 W
Spannungsversorgung		
Redundante Betriebsspannung	12–55 VDC	12–55 VDC
Überlastschutz	✓	✓
Verpolungsschutz	✓	✓
Mechanische Eigenschaften		
Gehäuse	Metall, IP30	Metall, IP30
Abmessungen in mm (B × H × T)	26 × 95 × 75	26 × 95 × 75
DIN-Schienenmontage oder Wandmontage	✓	✓
Betriebstemperatur		
Standard (–10...+65 °C)	✓	✓
Erweitert (–40...+75 °C)	✓	✓
Konformität/Zulassungen		
EN 61000-6-4 / EN 61000-6-2	✓	✓
FCC Part 15B / CISPR 22	✓	✓

Managed Ethernet Switch, M12, Bahnanwendungen



PGM-1802-M12XB-10GSFP-67



Artikel-Nr.	PGM-1600-M12XB-67	PGM-1802-M12XB-10GSFP-67	EGM-1600-M12XB-67	EGM-1802-M12XB-10GSFP-67
Allgemeine Spezifikationen				
Anzahl Ports	16	18	16	18
10/100/1000Base-Tx	16 (8P M12 X-coded)	16 (8P M12 X-coded)	16 (8P M12 X-coded)	16 (8P M12 X-coded)
100/1000Base-x SFP	-	2	-	2
1G/10G SFP+	16	16	-	-
IEEE 802.3at PoE+ (P.S.E.)	✓	✓	✓	✓
Spannungsversorgung				
Redundante Betriebsspannung	24-110 VDC (je nach Modell)	24-110 VDC (je nach Modell)	24-110 VDC (je nach Modell)	24-110 VDC (je nach Modell)
Versorgungsanschluss	4P M12 K-coded	4P M12 K-coded	4P M12 K-coded	4P M12 K-coded
Überlastschutz	✓	✓	✓	✓
Verpolungsschutz	✓	✓	✓	✓
DI/DO	5P A-coded	5P A-coded	5P A-coded	5P A-coded
Mechanische Eigenschaften				
Gehäuse	Metall, IP67	Metall, IP67	Metall, IP67	Metall, IP67
Abmessungen in mm (B × H × T)	295 × 183 × 105	295 × 183 × 105	295 × 183 × 105	295 × 183 × 105
Wandmontage	✓	✓	✓	✓
Betriebstemperatur				
Standard	-40...+60 °C	-40...+60 °C	-40...+60 °C	-40...+60 °C
Konformität/Zulassungen				
EN 61000-6-4 / EN 61000-6-2	✓	✓	✓	✓
FCC Part 15 B / CISPR 22	✓	✓	✓	✓
EN50155	✓	✓	✓	✓
EN50121-3-2	✓	✓	✓	✓
EN50121-4	✓	✓	✓	✓

Unmanaged Ethernet Switch, M12



ETU-0500-M12-67



Artikel-Nr.	ETU-0500-M12-67
Allgemeine Spezifikationen	
Anzahl Ports	5
10/100Base-Tx	5 (4P M12 D-coded)
10/100/1000Base-Tx	-
IEEE 802.3at PoE+ (P.S.E.)	
Jumbo Frame Bedienung	-
Spannungsversorgung	
Redundante Betriebsspannung	12-48 VDC
Připojení Spannungsversorgung	5P M12 A-coded
Überlastschutz	✓
Verpolungsschutz	✓
Relais 24VDC, 1A	-
Mechanische Eigenschaften	
Gehäuse	Kunststoff, IP 67
Abmessungen in mm (B x H x T)	37 x 216 x 46
Wandmontage	✓
Betriebstemperatur	
Standard (-10...+65 °C)	✓
Erweitert (-40...+75 °C)	✓
Konformität/Zulassungen	
EN 61000-6-4 / EN 61000-6-2	✓
FCC Part 15B / CISPR 22	✓
UL 61010	✓

IIoT Gateway



TLEG-71300-5120-T

Artikel-Nr.	TAEG-72300-5100-T	TLEG-71300-5120-T
Allgemeine Spezifikationen		
Uplink	WiFi 11ac (5GHz) i 11n(2.4GHz) 1x RJ45 Gigabit Ethernet	1x LTE cat.4 module2 (dual SIM) 1x RJ45 Gigabit Ethernet
LAN-RJ45 10/100/1000Base-Tx	4	4
LAN WiFi	802.11a/b/g/n/ac 2T2R (2.4G/5GHz)	802.11a/b/g/n/ac 2T2R (2.4G/5GHz)
Serielle Schnittstelle	1x RS232/RS485 (4-pin)	1x RS232/RS485 (4-pin)
I/O	1x DI ("Logic 0": 0~2V, "Logic 1": 5V~30V), 1x DO (Relais, 30V / 1A)	1x DI ("Logic 0": 0~2V, "Logic 1": 5V~30V), 1x DO (Relais, 30V / 1A)
Externer Speicher	1 USB 2.0	1 USB 2.0
Spannungsversorgung		
Redundante Betriebsspannung	12-48 VDC	12-48 VDC
Mechanische Eigenschaften		
Gehäuse	Metall, IP30	Metall, IP30
Abmessungen in mm (B x H x T)	54 x 142 x 99 62 x 125 x 160 (Ohne DIN-Schienenmontageadapter) 62 x 135 x 160 (Mit DIN-Schienenmontageadapter)	54 x 142 x 99 62 x 125 x 160 (Ohne DIN-Schienenmontageadapter) 62 x 135 x 160 (Mit DIN-Schienenmontageadapter)
DIN-Schienenmontage oder Wandmontage	✓	✓
Betriebstemperatur		
Standard	-30...+70 °C	-30...+70 °C
Eigenschaften		
WAN	Multiple WAN, Failover/LoadBalance	
WiFi	AP Router, WDS	
VLAN	Port-based, Tag-based	
Virtual COM	RFC2217, TCP Client, TCP Server, UDP	
Modbus	Modbus Slave, Modbus Gateway für Modbus TCP Master/Slave, Modbus RTU/ASCII Master/Slave	
OPC UA	OPC UA Server, IEC 62541 konform, Device Tag & Modbus Proxy Rules	
MQTT	MQTT Broker, Broker Bridge, MQTT Client	
Sicherheit	VPN, IPsec, Firewall, Zugangskontrolle	

Kabeldurchführungen



Gummidurchführungen
DES-PDM M mit
Mutter



Gummidurchführungen
DES-PDM mit festem
Rahmen



Rahmendurchführungen
geteilt DES



Geteilte Durchführungen DES
CLICK



Gummidurchführungen
DES-PM 24



Gummidurchführungen
DES-PM M

Softwarefunktionen

IP Routing (statisches Routing)

Mit IP-Routing kann man eine Übertragungsleitung bestimmen, die ein Datenpaket vom Quellgerät, das sich in einem Netzwerk befindet, zum Zielgerät in einem anderen Netzwerk leitet. Die Leitungen werden als Einträge in einer Tabelle definiert.

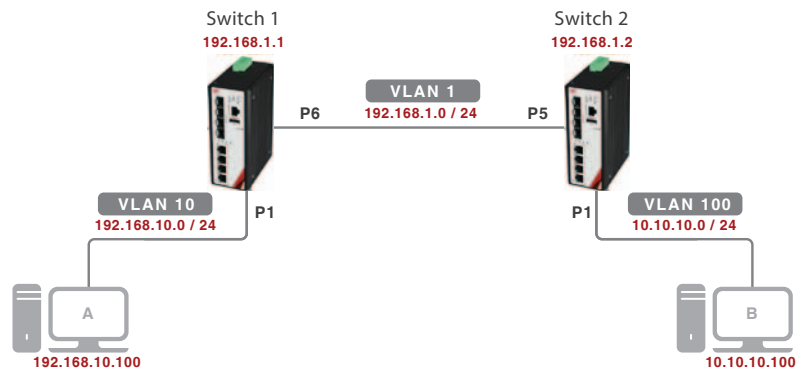

DHCP-Relay

DHCP-Relay übermittelt DHCP-Nachrichten zwischen Clients und Server, die sich in verschiedenen Subnetzwerken befinden.

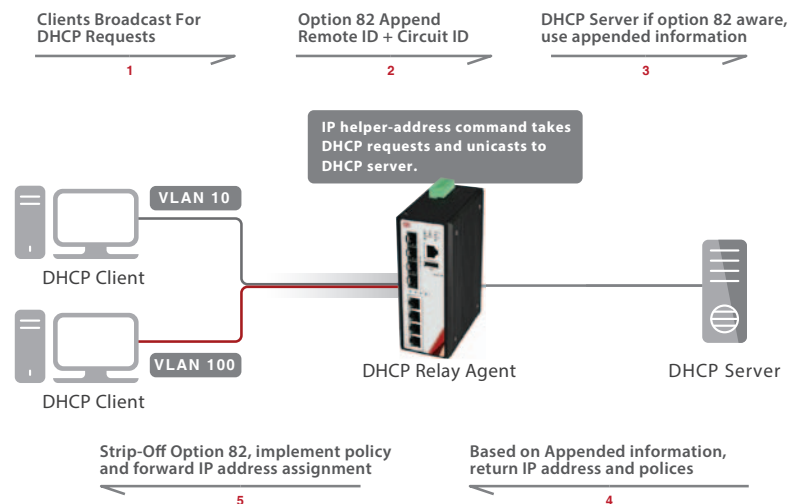

DHCP-Snooping

DHCP-Snooping-Funktion blockiert einen angreifenden Eindringling, wenn er versucht durch einen nicht vertrauenswürdigen Port eine falsche DHCP-Antwort in ein legitimes Gespräch zwischen einem Client und DHCP-Server injizieren.

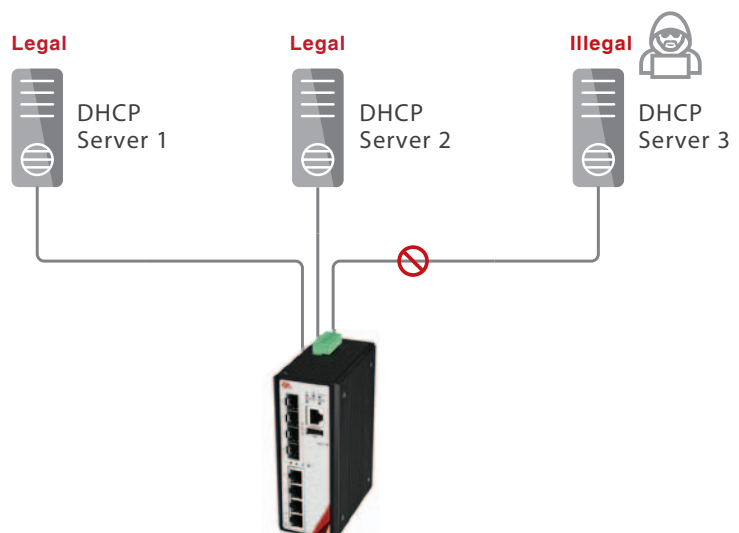

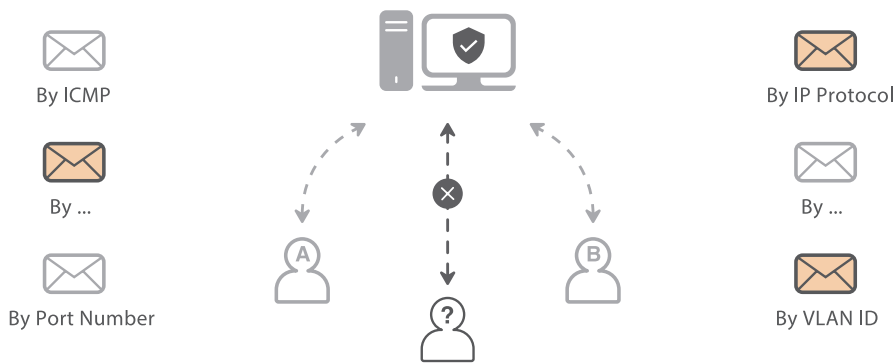

ACL

Zugriffssteuerungsliste (engl. ACL - Access Control List) ist eine Reihe von Regeln, die zum Filtern des Netzwerkverkehrs dienen. ACL kann eine Liste von Bedingungen enthalten, die bestimmen, wann Datenverkehr zugelassen wird und wann es gesperrt werden soll. Diese Regel können für eingehende oder/und ausgehende Pakete gelten.

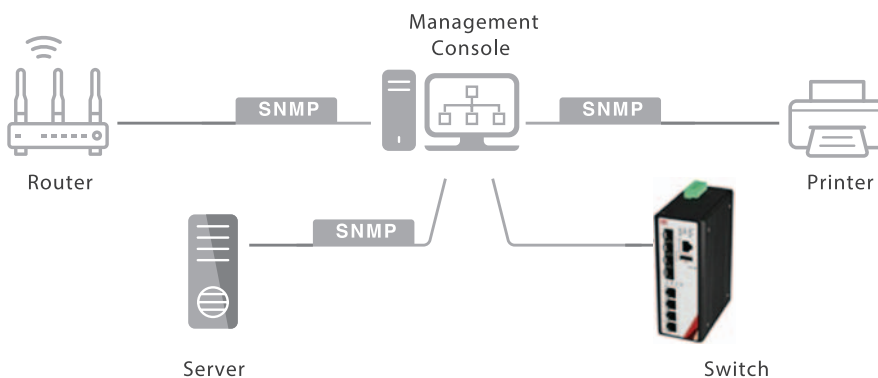

SNMP

SNMP ist ein einfaches und weit verbreitetes Protokoll, der zur Verwaltung von IP-Netzwerke dient. Mit SNMP kann man nicht nur die Informationen von den Netzwerkgeräten sammeln und organisieren, aber auch deren Konfiguration ändern.

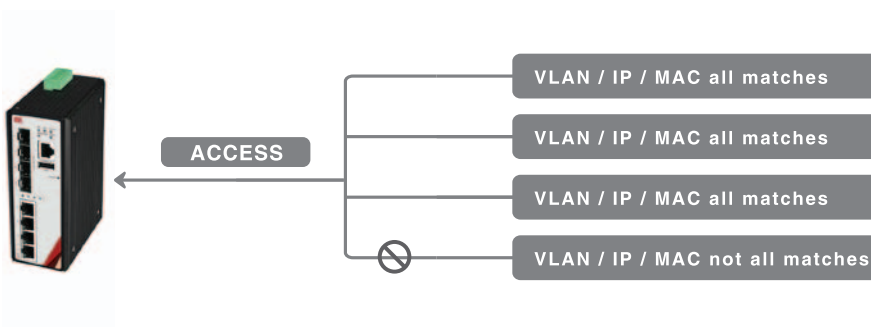

IP Source Guard

Diese Funktion verhindert die Angriffe, in denen der Angreifer entführt eine legitime IP-Adresse

IEEE 802.1X

IEEE 802.1X ist ein Standard für die Netzwerkzugriffskontrolle, die auf vertrauenswürdigen Ports basiert. (PNAC - Port-based Network Access Control).

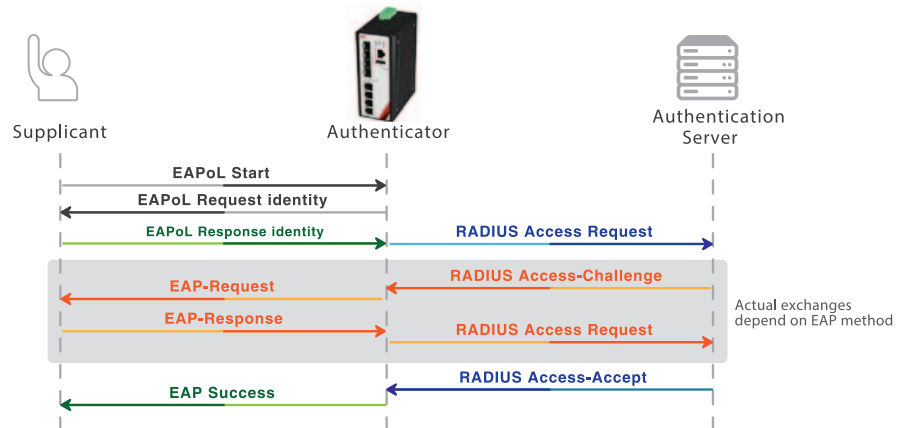

RSTP (Spanning Tree)

RSTP ist ein Verbindungsredundanz Protokoll, das im Falle einer Störung eine automatische Wiederherstellung des Netzwerks ermöglicht. Dabei entsteht kein Risiko der Bildung von Schleifen. RSTP löst das Problem der Zeitlücke beim Umschalten, die bei Verwendung von STP-Protokoll auftritt. Als Folge werden bei Leitungsausfall neue Portzustände innerhalb von einigen Sekunden berechnet und umgeschaltet.

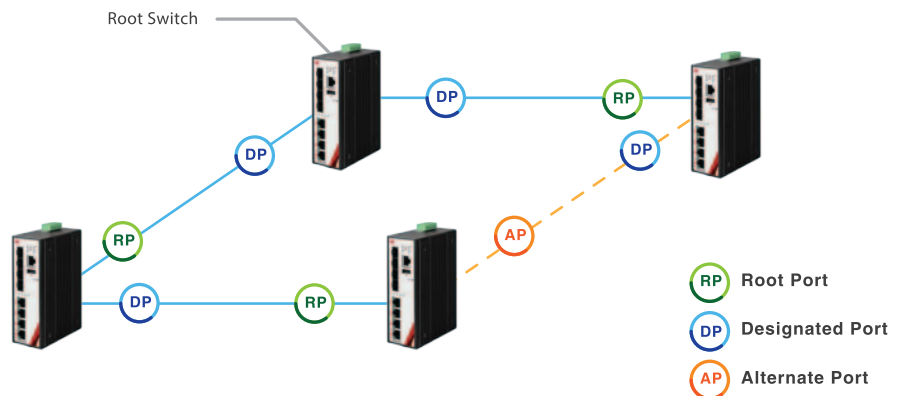

MSTP

MSTP ist eine Erweiterung des Protokolls RSTP. Es erlaubt mehrere Spanning-Tree-Topologien gleichzeitig zu definieren basierend auf der Zuweisung von Datenpaketen zu verschiedenen VLANs. Ein Port, der mehreren VLAN Netzwerken gehört, kann in einer Topologie blockiert sein, indem in anderen können die Datenpakete weiterleitet werden.

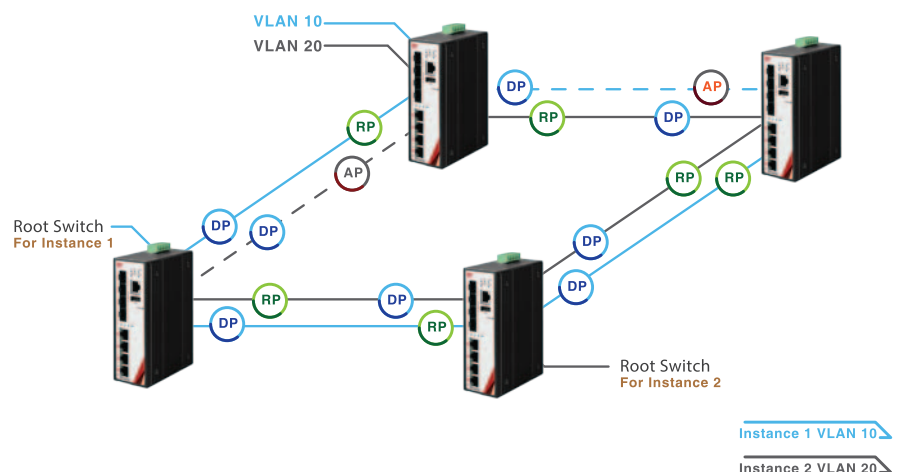

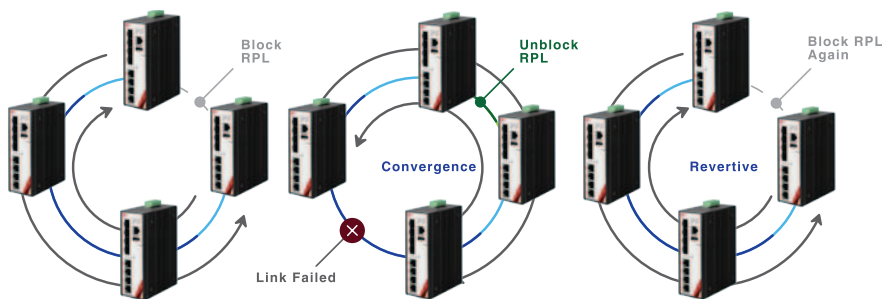

ERPS

ERPS ist ein Protokoll für eine schnelle Netzwerkredundanz in einem Netzwerk mit der Ring-Topologie. Dieser Standard wurde von ITU-T unter der Nummer G.8032 definiert. ERPS macht eine Verbindungswiederherstellungszeit unter 50 ms möglich und garantiert dass beim Umschalten keine Schleife entsteht.

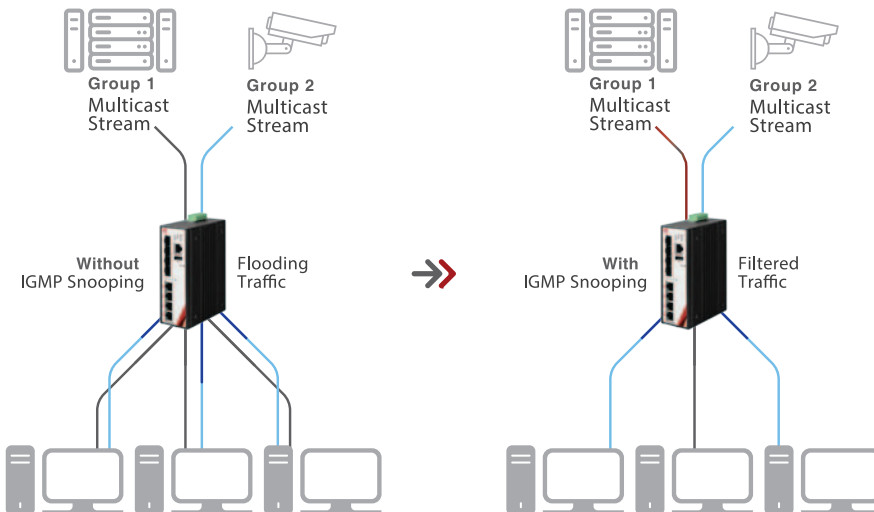

IGMP Snooping

Beim IGMP-Snooping wird beim IGMP Netzwerkverkehr durch den Switch aktiv zugehört und analysiert. Auf diese Weise wird eine Karte hergestellt, wo alle Multicast-Streams Verbindungen gezeichnet werden. Dann, der Karte nach, werden die einzelnen Multicast-Streams nur für den relevanten Hosts weitergeleitet, was wesentlich überflüssiges Netzwerkverkehr reduziert.

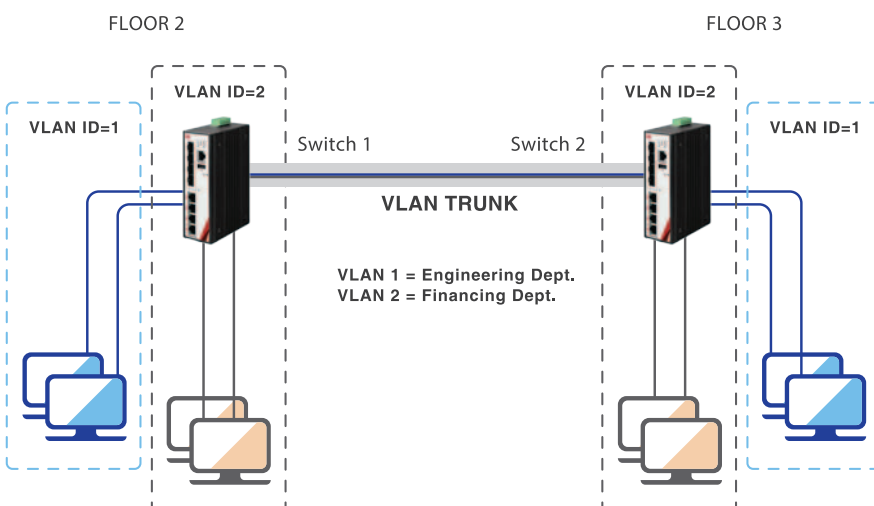

VLAN

Standard IEEE 802.1Q für virtuelle LAN (VLAN) definiert ein System, wo Datenpakete mit Etiketten markiert werden, sodass die Zugehörigkeit zum VLAN gekennzeichnet wird. Dadurch ist die Isolierung der Daten von verschiedenen VLANs möglich.

QoS

Mit QoS (Quality of Service) kann der Benutzer gewünschte Prioritäten für bestimmte Datenarten einräumen, sodass die wichtigen Daten immer zuverlässig übertragen werden.

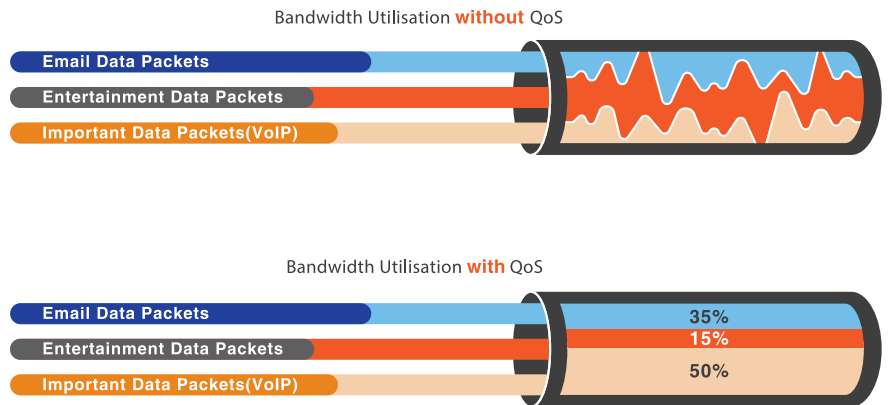

Aggregation

Die Aggregation ist eine Methode für die Erhöhung der Bandbreite des Links durch parallele Verbindung von mehreren Leitungen. Bandbreite von so einem Link ist höher als einer einzigen Leitung. Dadurch wird auch Leitungsredundanz verbessert.

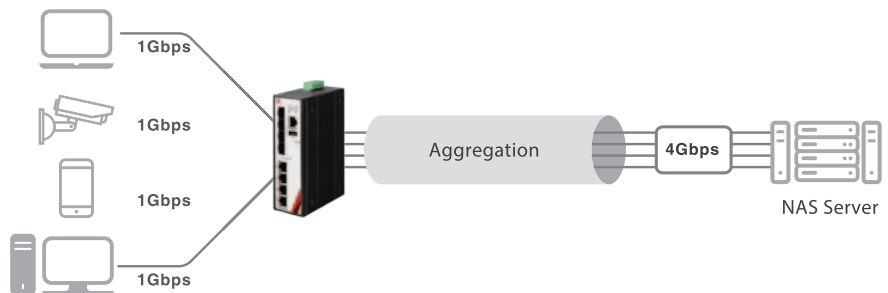

TACACS+

TACACS+ ist ein Netzwerkprotokoll, das bietet Zugangskontrolle zu Router, Server und andere Netzwerkgeräte über einen oder mehrere zentrale Server.

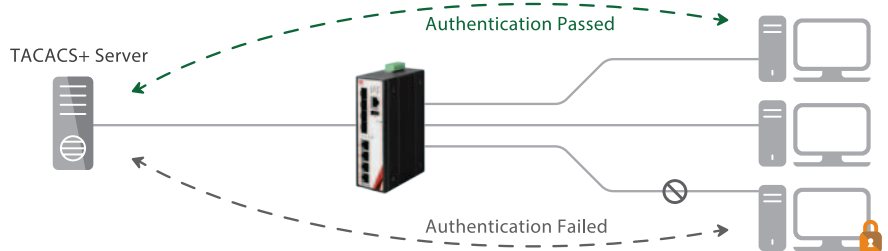

Fehlermanagement

Fehlermeldungen sind die wichtigste Kommunikationsform zwischen dem System und dessen Administrator. Sie informieren über Störungen sofort, ohne dass Status vom Administrator geprüft sein muss.

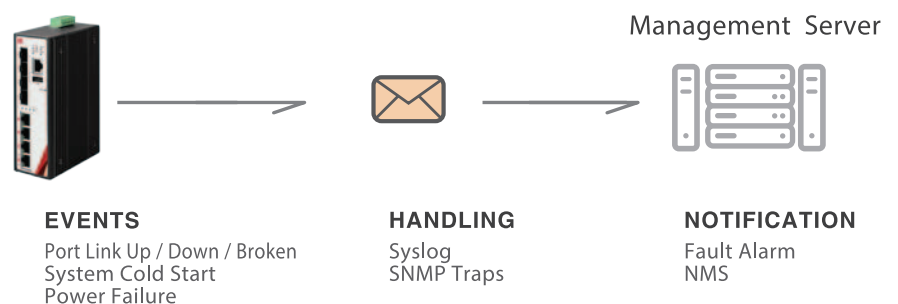

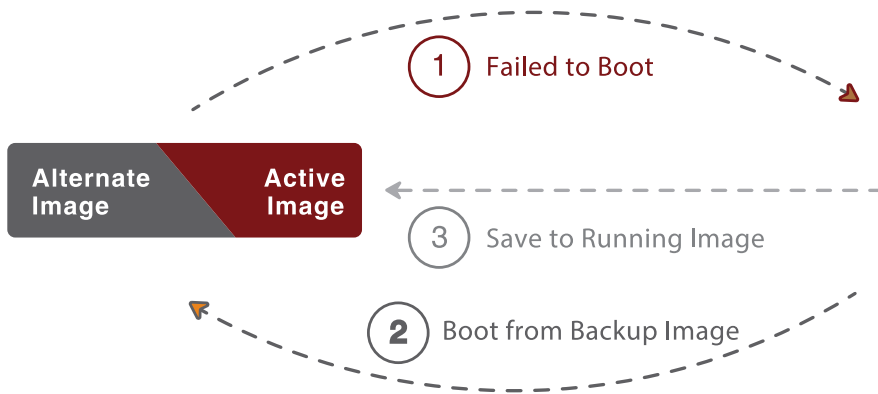

Software-Image-Auswahl

Der Switch kann im remanenten Speicher zwei Software-Images enthalten. Der Benutzer kann entscheiden, welcher von den beiden beim Neustart geladen wird.

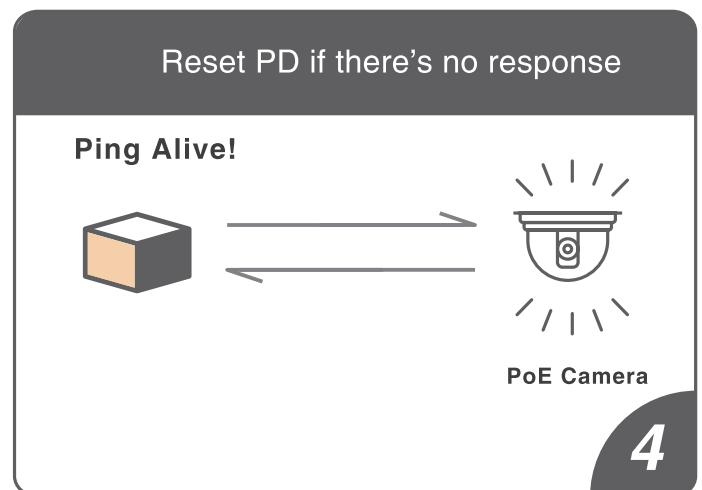
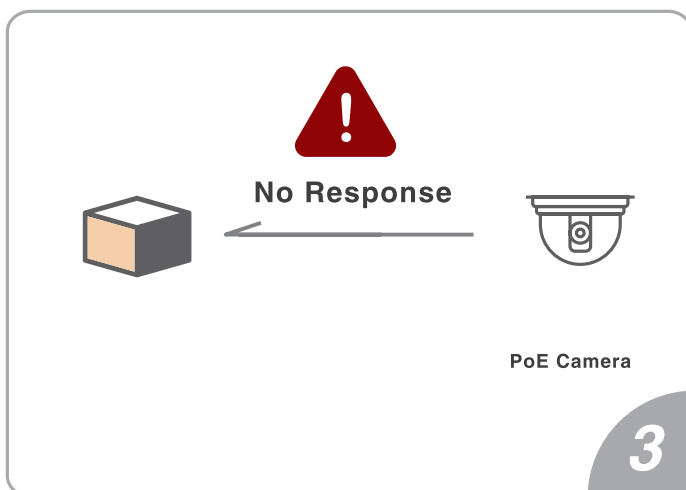
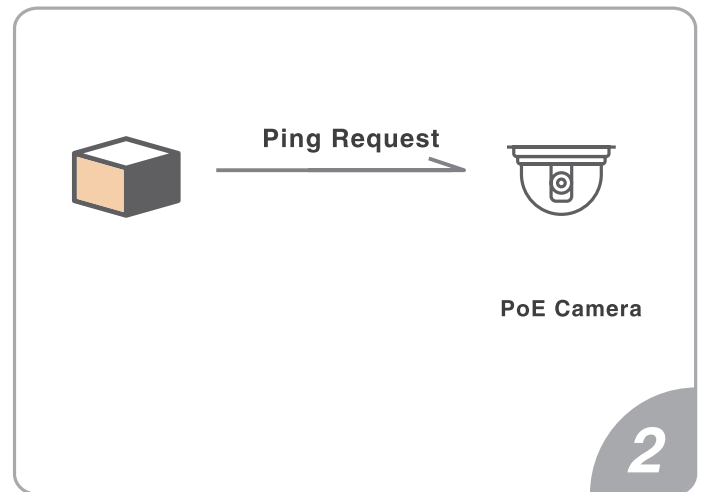
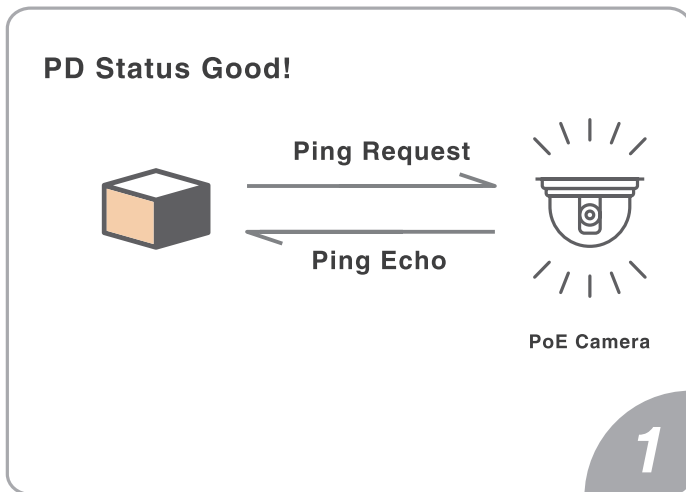

Ping PoE

PoE-versorgte Geräte können durch den Switch mit dem zyklischen PING überwacht werden. Falls das Gerät nicht reagiert, kann es automatisch neu gestartet werden.

PoE-Zeitplan

PoE-versorgte Geräte können nach dem definierten Zeitplan ein- und ausgeschaltet werden.

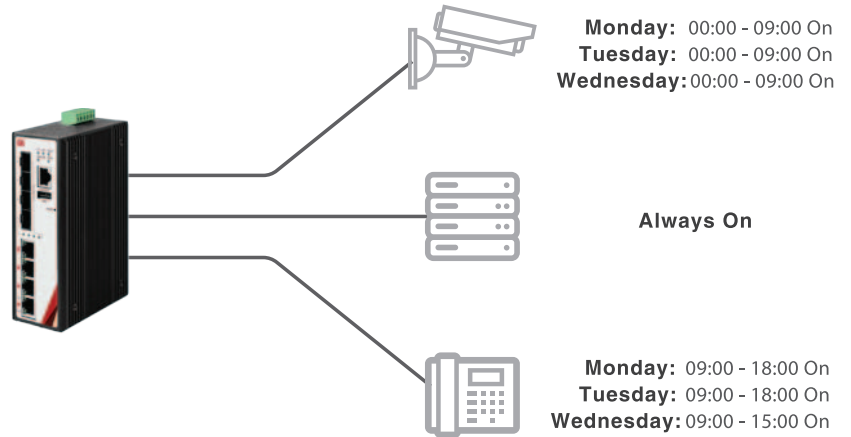

PoE-Prioritäten

PoE-versorgte Geräte können die Prioritäten zugewiesen werden, sodass im Falle der Überlastung die weitere Arbeit der kritischen Geräte gewährleistet bleibt.

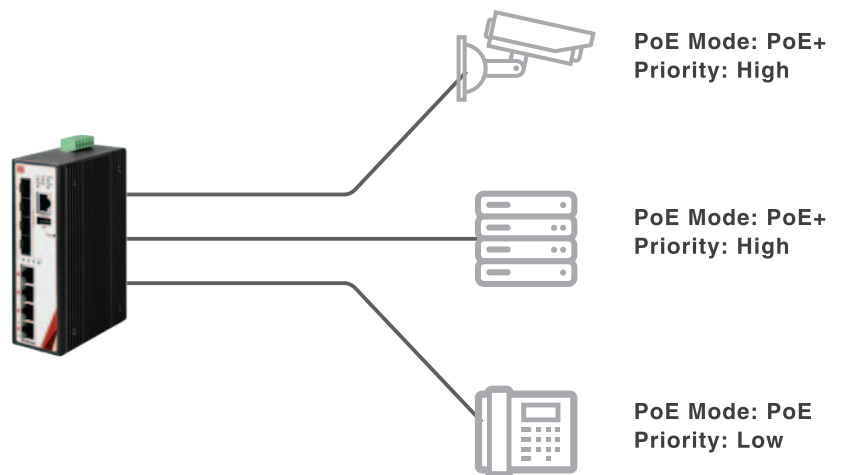

SCHALTSCHRANKTECHNIK



Industrielle Kommunikationstechnik



Ethernet Switch



PROFIBUS und PROFINET Stecker und Kabel



USB und RJ45 Stecker, Ventilstecker



Stecker Rechteck



Vorkonfektionierte Frontstecker



Kabeldurchführungen, Verschraubungen



Kabeldurchführungssysteme für nicht vorkonfektionierte Kabel



Teilbarer Rahmen für vorkonfektionierte Kabel



EMV-Abschirmung



Kabelverschraubungen, Kunststoff, Messing, EMV, ATEX



LED Leuchten, Netzgeräte



LED Leuchtsäulen



Schaltschrankleuchten



Arbeitsleuchten



Netzgeräte



Multifunktions Messgeräte



Temperaturregler



Zähler



Messgeräte



Prozeßanzeigeranzeiger



Volt-Ampermeter



Relais, Zeitrelais, Überwachungsrelais



Industrirelais



Halbleiterrelais



Zeitrelais



Zeitschaltuhren



Überwachungsrelais



Schaltschrankzubehör



Schaltschranklüfter



Schaltschrankheizungen Thermostate



Schaltschranksteckdosen



Kennzeichnungen



Schwimmerschalter

SENSORTECHNIK



Standard-sensorik



Lichtschränken



Induktive und Kapazitive Sensoren



Ultraschallsensoren

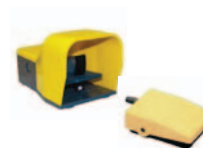

Fußschalter



M8 und M12 Kabel und Stecker



Spezialsensorik



Farbkontrolle und Farbmessung

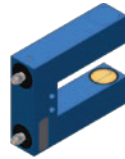

Abstandsmessung und Positionierung



Oberflächenkontrolle und Zählaufgaben



Produktkennzeichnung und Produktverfolgung



Sensorik für die Aufzugs- und Torindustrie



Lichtvorhänge



Lichtschränken



Reflexions-Lichttaster



TOF 3D Sensoren



Positionierungs und Steuerungssysteme

MESS- UND REGELTECHNIK



Druck/Strömung



Druckschalter



Differenzdrucktransmitter



Luftstrom-Geschwindigkeits-transmitter



Druck- und Durchflußregler



Drucktransmitter für Flüssigkeiten



Temperatur, Feuchte, CO₂, Anzeigeräte



Raumfühler für Temperatur, Feuchte und CO₂



CO₂ und Feuchtetransmitter



Temperatursensoren-Kabelfühler, Anlegefühler, Tauchsensoren, Frostschutzsensor



Differenzdruck-Zeigermanometer und Schräghrohrmanometer



Luftqualitätsfühler CO₂ und VOC

INDUSTRIELLE NETZWERKKOMPONENTEN



Preise in Euro, exkl. MwSt., Lieferbar ab 01. 01. 2023, freibleibend, Auftragsrabatt auf Anfrage. Irrtümer und technische Änderungen vorbehalten.



ERGATE Automation DE
Kornstraße 17, 85304 Ilmmünster
Tel.: +49 84 418946-0
E-mail: office@ergate.de

ERGATE Automation AT
Venediger Au 5/14, 1020 Wien
Tel.: +43 664 5262857
E-mail: office@ergate.at

   
www.ergate.de
www.ergate.at